

Ohm 140/115 LED 3000K

A family of porcelain luminaires for walls, ceilings and tables. Designed by Kauppi & Kauppi, the soft curves and restrained silhouette references to both Scandinavian design and ancient Japanese tableware.

EAN / GTIN	7312908351805
E-number	7505306
Article no.	8351-800-10
Type designation	51822/LED



Specification

Material	Porcelain
Base colour	White (NCS S 1000-N)
Glass	Matt opal glass
Glass thread (mm)	123,5 mm
Glass gasket	Silicone
Weight	1,37 kg
Diameter (mm)	138
Height (mm)	112
Lamp holder	LED
Light source	LED module, 10W **
Effect	10W
Lumen, light source	1000lm
Lumen, luminaire	572
Colour temperature	3000K
MacAdam	3 SDCM
Life span	L80/B10: 47 000 h
Ra	Min 90
Rated voltage	230V
Dimmable	RC mode
IP class	IP44
Insulation class	I
Energy class	F
D class	No
IK class	IK02
Ta	-30 - +25
Installation	Ceiling/wall
CC measurement (mm)	60-66, 70
Knock out opening	0
Cable inlet	Bottom inlet
Cable glands	Bottom inlet
Cable area, max	Max 3 x 2,5 mm ²
Bridging	Yes
Surface mounted cable	No
Connection	Terminal block
Family	Ohm
Design	Kauppi & Kauppi

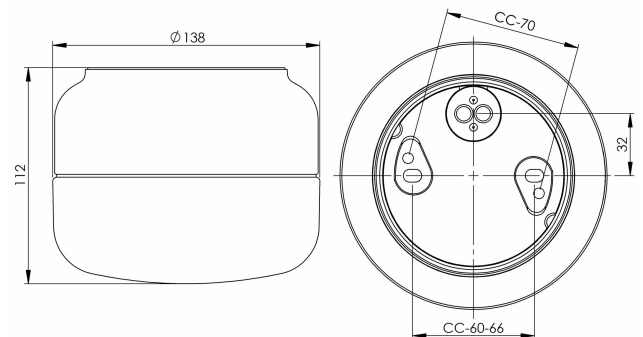

Maintenance

Disconnect the power to the luminaire. Unscrew the glass and clean it. Do not use detergents that contain solvents. Replace light source if necessary. Check the gasket and replace it if necessary. Screw the shade back on.

Spare parts

Shade Ohm 140/115 matt opal, Article no.: 1-6167-30
Gasket silicone for thread 123,5 mm, Article no.: 02789
LED module 10W 3000K, Article no.: 1-54056-930

**** The device must under no circumstances be connected to the same phase as a magnetic ballast or other older fluorescent luminaires as these luminaires can generate overvoltage transients outside of EU regulatory standards when switched off or on. The luminaire can permanently damage or completely cease to function when connected.**

If the luminaire is modified the person responsible for the modification shall be considered manufacturer. Subject to errors in text. We reserve the right to change the technical specifications (without notice).