

Opus 100/175 LED 2700K

Opus 100/175 LED is an elegant, cylindrical shaped light fitting. Its timeless design is suitable for wall or ceiling installation, both indoors and outdoors.

EAN / GTIN	7312908241816
E-number	7504363
Article no.	8241-801-10
Type designation	8241/LED



Specification

Material	Porcelain
Base colour	White (NCS S 1000-N)
Glass	Matt opal glass
Glass thread (mm)	84,5 mm
Glass gasket	Silicone
Weight	1 kg
Diameter (mm)	97
Height (mm)	171
Lamp holder	LED
Light source	LED module, 8W **
Effect	8W
Lumen, light source	800lm
Lumen, luminaires	632
Colour temperature	2700K
MacAdam	3 SDCM
Life span	L80/B10: 47 000 h
Ra	Min 90
Rated voltage	230V
Dimmable	RC mode
IP class	IP44
Insulation class	I
Energy class	F
D class	No
IK class	IK02
Ta	-30 - +25
Installation	Ceiling/wall
CC measurement (mm)	60-66, 70
Knock out opening	0
Cable inlet	Bottom inlet
Cable glands	Bottom inlet
Cable area, max	Max 3 x 2,5 mm ²
Bridging	Yes
Surface mounted cable	No
Connection	Terminal block
Family	Opus
Design	Duoform

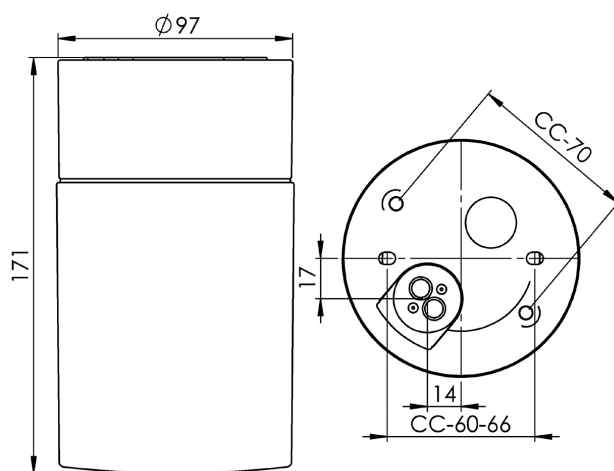

Maintenance

Disconnect the power to the luminaire. Unscrew the glass and clean it. Do not use detergents that contain solvents. Replace LED module if necessary. Check the gasket and replace it if necessary. Screw the shade back on.

Spare parts

Shade Opus 100/175 matt opal, Article no.: 1-6182-30
 Gasket silikon for thread 84,5 mm, Article no.: 02786-9
 LED module 8W - 2700K, Article no.: 1-54057-927

**** The device must under no circumstances be connected to the same phase as a magnetic ballast or other older fluorescent luminaires as these luminaires can generate overvoltage transients outside of EU regulatory standards when switched off or on. The luminaire can permanently damage or completely cease to function when connected.**

If the luminaire is modified the person responsible for the modification shall be considered manufacturer. Subject to errors in text. We reserve the right to change the technical specifications (without notice).