

Opus 200/190

Opus 200 is an elegant cylindrical formed light fitting. Its timeless design is suitable for wall or ceiling installation, both indoors and outdoors.

EAN / GTIN	7312907266209
E-number	7511468
Article no.	7266-500-10
Type designation	7038A
Norwegian El-number	3212912
Finnish S-number	4211925



Specification

Material	Porcelain
Base colour	White (NCS S 1000-N)
Glass	Matt opal glass
Glass thread (mm)	185,5 mm
Glass gasket	Silicone
Weight	2,00 kg
Diameter (mm)	202
Height (mm)	194
Lamp holder	E27
Light source	E27, max 75W (not included)
Effect	Max 75W
Rated voltage	230V
IP class	IP44
Insulation class	II
D class	No
IK class	IK02
Ta	-30 - +25
Installation	Ceiling/wall
CC measurement (mm)	133, 70
Knock out opening	3
Cable inlet	Bottom inlet
Cable glands	Bottom inlet
Cable area, max	Max 2 x 2,5 mm ²
Bridging	Yes
Surface mounted cable	Yes
Connection	Screw connector
Family	Opus
Design	Duoform

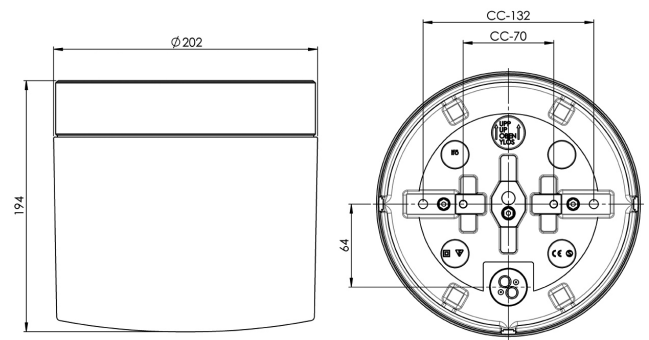

Maintenance

Disconnect the power to the luminaire. Unscrew the glass and clean it. Do not use detergents that contain solvents. Replace light source if necessary. Check the gasket and replace it if necessary. Screw the shade back on.

Spare parts

Shade Opus 200/190 matt opal, Article no.: 1-6185-30
Gasket silicone for thread 185,5 mm, Article no.: 03431

If the luminaire is modified the person responsible for the modification shall be considered manufacturer. Subject to errors in text. We reserve the right to change the technical specifications (without notice).